

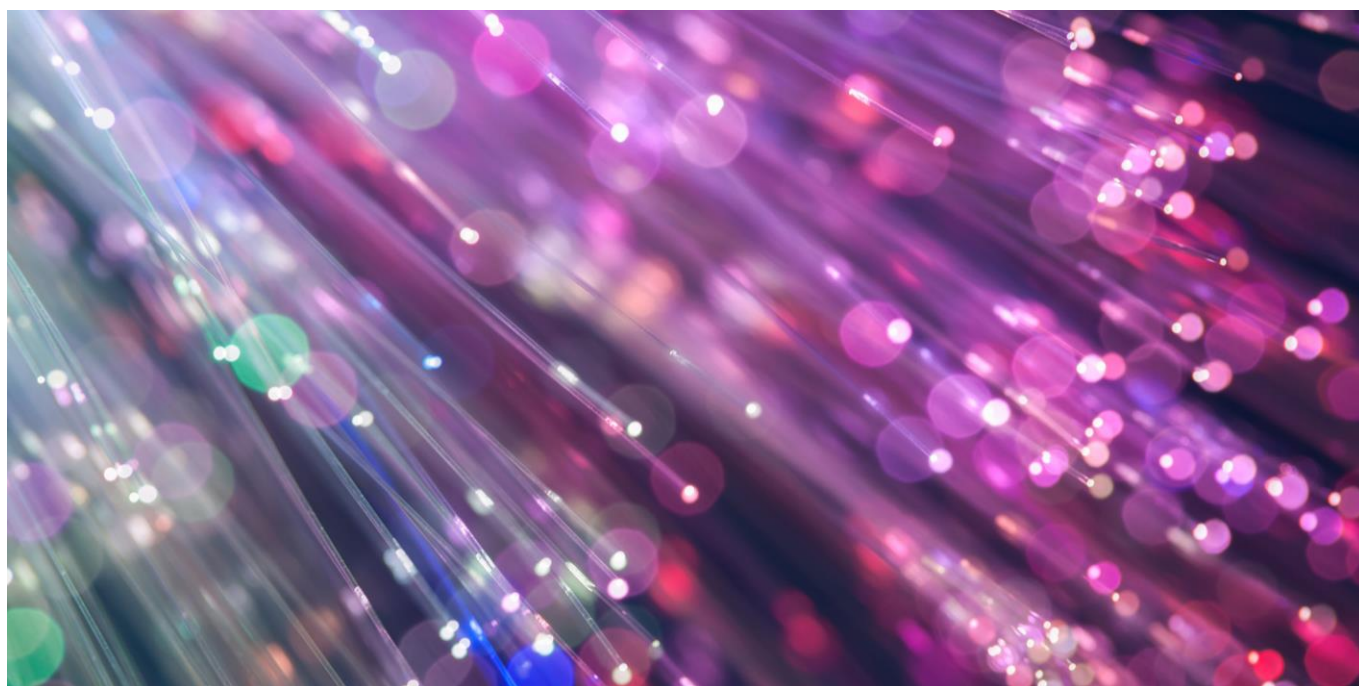

Fibre to the Home Networks

GTC Technical Guidelines

GTC Technical Guidelines and Safety Information for
House Builders and Developers



GTC Technical Guidelines

Contents

1. Introduction.....	4
2. Communications.....	5
3. Safety	6
4. Project Life Cycle.....	11
5. On Site Convergence Point (OSCP) Responsibilities and Requirements	14
6. Ducting Requirements	20
7. Chamber Requirements	28
8. MDU Requirements	32
9. Works at ONT Location and for in Premises Distribution Cabling.....	35
10. Testing	42
11. Appendices	43

Section One

Introduction

This document will provide you with information and guidance on the installation of fibre ducts, fibre services and home installation requirements to new housing developments. The document is designed to enable you to undertake the works to provide the minimum requirement necessary to enable service. It does not preclude you from adding supplementary requirements to meet local or customer specific needs.

Where a Fibre Integrated Reception System (FIRS) is specified it will give the ability to distribute a full range of digital television signals (satellite and terrestrial) and DAB radio from a central location to individual premises on the site. If your development has a FIRS solution, please consult our *FIRS Technical Standards GF-CIC-ES-0059* guidance which needs to be followed in conjunction with this document.

Our Sales Team will assist you with any enquiries you may have and will deal with technical enquiries through our Engineering, Planning and Operations departments.

Should you wish to contact us, the telephone number is 01359 240363

Disclaimer

Although the greatest of care has been taken in the compilation and preparation of this document, GTC respectfully accepts no responsibility for any errors, omissions or alterations or for any consequences arising from the use, or reliance upon the information in this document.

Section Two

Communications

Our opening hours are from 08.00 to 17:00 every weekday. The below is a list of contact details for various parts of the customer journey.

Fibre Emergency

To report damage to a fibre plant or OSCP, please call **02920 028726** (24 hours).

Gas Emergency

If you can smell gas or believe a gas pipe has been damaged, please call **0800 111 999** (24 hours).

Electricity Emergency

To report No Supply or Electrical Damage, please call **0800 0326990**

Sales

To discuss your utility infrastructure solution needs and obtain a quotation, please contact **01359 240154** or **sales@gtc-uk.co.uk**

Design

To discuss a utility design or request a variation, please contact **01359 300798** or **network_variations@gtc-uk.co.uk**

Customer Services

At GTC, we are committed to providing you with excellent customer service and we encourage feedback so that we may ensure we are making our customers happy. If you have any comments or complaints about our service, please contact **01359 302640** or **customerservices@gtc-uk.co.uk**

Legals

To discuss legal transactions in relation to easements and transfers over our utilities, please contact **01359 243453** or **legals@gtc-uk.co.uk**

Site Installation

To book in work on your site, please contact **0845 6022498** or **gtcworks@gtc-uk.co.uk**

Supplier Agreements

To check and change supplier/shipper contract agreements, please contact **01359 243311** or **psr@gtc-uk.co.uk**

Finance Queries

For any queries regarding invoices or billing, please contact **01359 308144** or **credit.control@gtc-uk.co.uk**

Section Three

Safety

Safe Place of Work

GTC requires a safe place of work to be provided for all its staff and contractors. We will seek confirmation that the construction site is a safe place to work.

Upon arrival on site, staff and contractors will report to the Site Manager/Representative to discuss intended works. Prior to undertaking this work, a site-specific risk assessment will be undertaken. If, following this assessment, the works cannot be undertaken in a safe manner, the Site Manager/Representative will be informed. Until a safe working environment is achieved, no activities shall be undertaken.

Site Traffic Rules

All site traffic information should be made available to the team/operative when arriving on site, via a site induction or during the booking in on-site stage.

Equipment and Materials

All materials will be handled, transported, stored and fixed in accordance with the manufacturer's requirements. Any conflict between such requirements, this documentation and the British Standards Institution, shall be referred to GTC in writing for a decision.

The Site Manager/Representative shall ensure their equipment and materials are operated and stored in such a manner that they do not become a hazard within the working area of the GTC team/operative.

Scaffold

Ensure all scaffolding where the team/operatives are to work is removed prior to their arrival on site.

Welfare Facilities

In most cases, welfare facilities are to be made available on site from the Principal Contractor.

GTC Technical Guidelines

Competence

Any staff and/or appointed contractor working on behalf of GTC who attend site will have the appropriate training, technical knowledge and experience to discharge the intended works in a safe manner.

Construction Design Management (CDM) Regulations

GTC will act as the 'Designer' and 'Contractor' for the construction and commissioning of fibre networks on new property developments. The fibre infrastructure that will be installed on the development will typically remain the property of the licenced Fibre Telecommunications Operator named in your quotation.

Recommended Positioning of Utility Apparatus

The typical NJUG position of the fibre duct infrastructure and other utilities apparatus in a footway is shown below, however where GTC are installing fibre, electricity and gas, the low voltage electric cables and fibre ducts should be installed at 600mm depth. The typical position in a road/verge is also shown below. All dimensions shown are in mm.

GTC Technical Guidelines

Pre October 2019

This diagram is NOT to scale and indicates the typical depth of cover required.

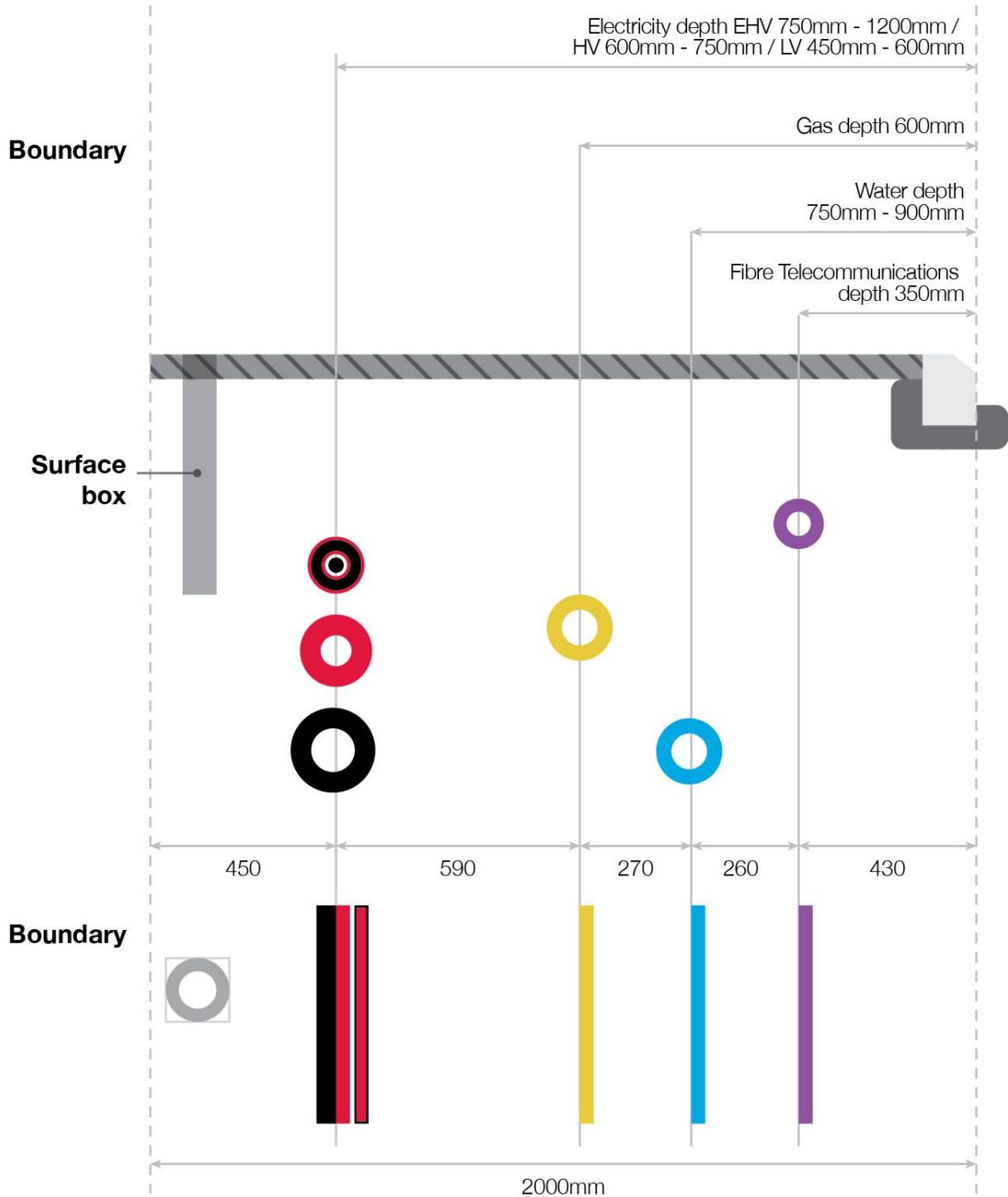

Figure 1 – NJUG positioning of utility apparatus in a two metre footway

GTC Technical Guidelines

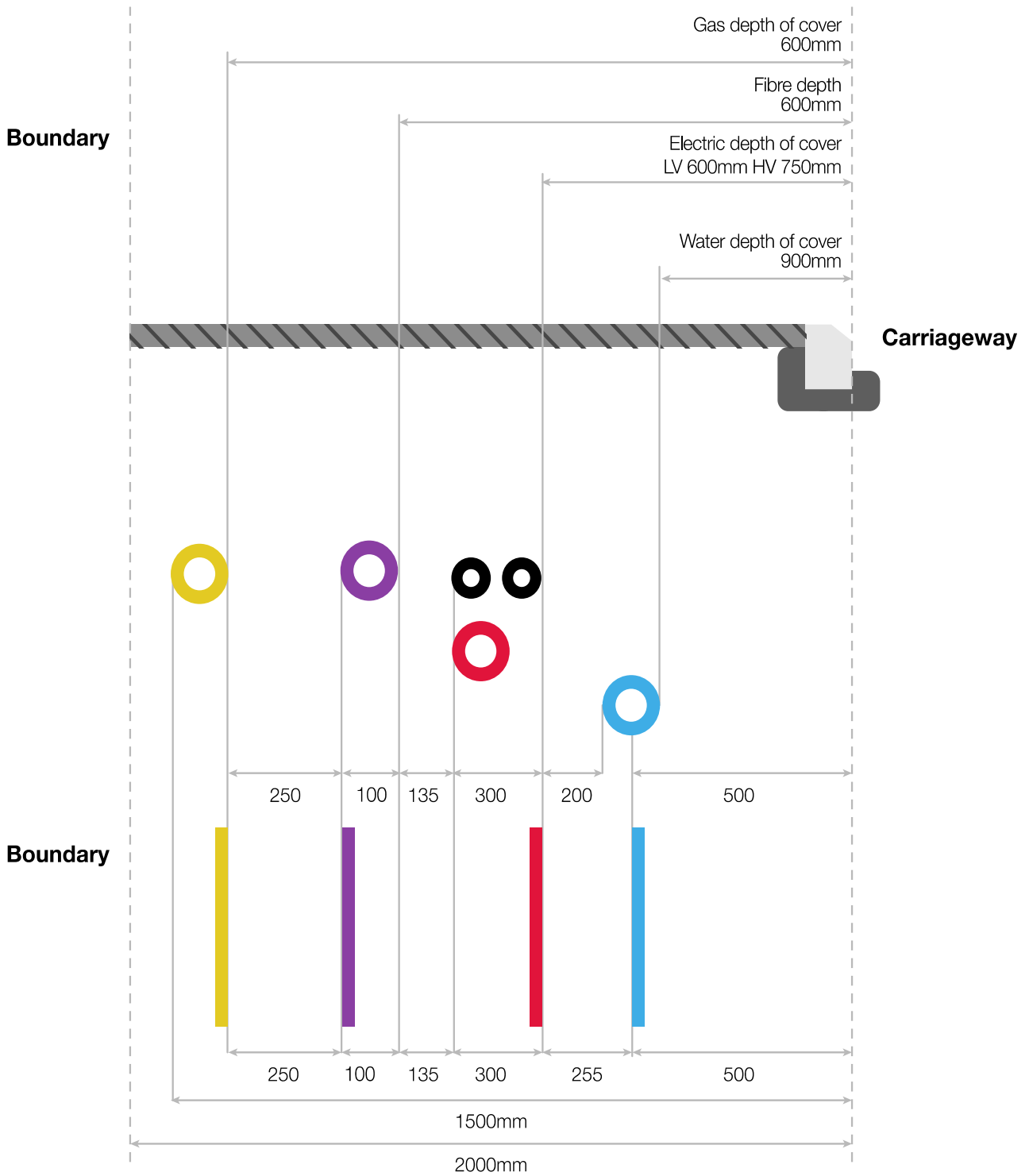

Figure 2 – GTC positioning of multi-utility apparatus in a two metre footway (Gas, Electricity and Fibre)

GTC Technical Guidelines

This diagram is NOT to scale and indicates the typical depth of cover required

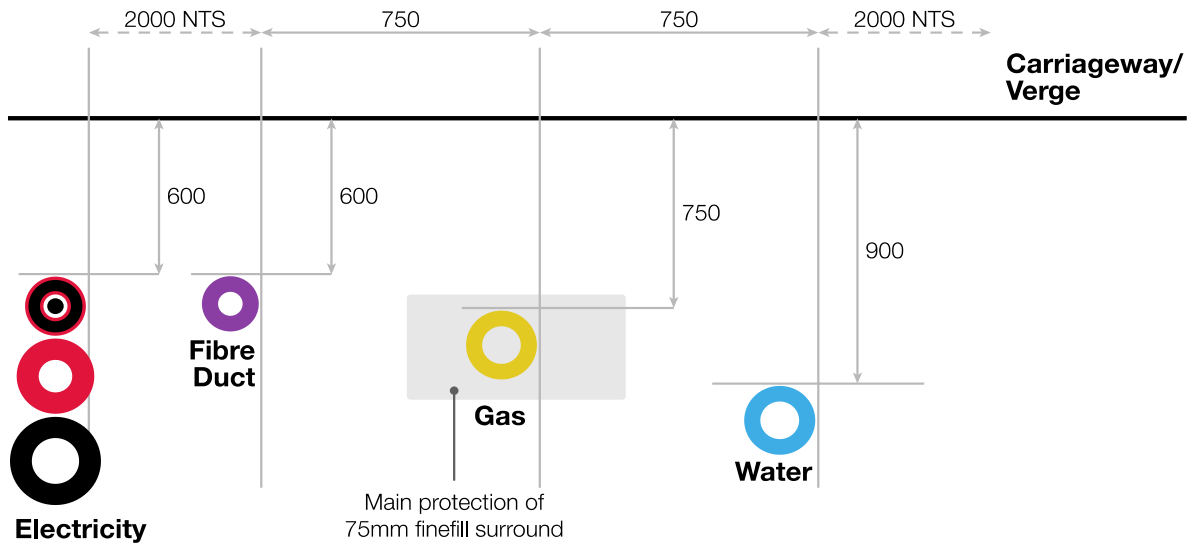

Figure 3 – Typical road section to show relative positions of utility apparatus

It is imperative that the fibre ducts are not damaged following installation and it is the responsibility of the Developer to ensure that ALL contractors working on-site are informed of the location of the fibre ducts and cables. The fibre duct mains and fibre services cable drawing should be on site at all times and updated to clearly show the installation progress. GTC will ensure that updates to the drawings are provided for your records.

Damage to GTC’s fibre ducts and cables must be reported immediately to the **GTC Fibre Emergency number 02920 028726**.

For further information refer to HSE publication HSG47 *Avoiding Danger from Underground Services* which gives detailed guidance on detecting underground services and safe digging practices.

Free information is available from the **HSE Infoline on 0845 345 0055** or the **HSE website www.hse.gov.uk**.

Section Four

Project Life Cycle

Prestart Meeting

Prior to the beginning of Works on site, a pre-start meeting will be arranged by GTC with all parties that are expected to direct installation of OFNL materials. A pre-start checklist and where applicable, a schedule of additional information requirements form, will be completed.

Where it is indicated on either the pre-start checklist or the additional information requirements form as your responsibility, you agree to provide any additional information so requested or provide clarification as soon as possible.

We will not be responsible for any delay to the Programme of Works caused in whole or in part by a failure to provide any applicable pre-start checklist clarification or additional information requirements in good time.

At the pre-start meeting we also require confirmation of the status of your relevant planning permission. Where applicable, you may be required to enter into a way leave agreement with us so that we have the necessary rights to access, lay, use, inspect, maintain, repair, replace, remove and renew the Equipment and/or Installation Materials provided.

Programme of Works

You should give GTC as much notice as possible of any changes or anticipated changes to the Programme of Works in order that this change can be managed.

It should be understood that any delay to the Programme of Works could have a like for like delay in the ability of GTC to complete our works and we will not be liable for this delay. Where a variation to the site or building layout is deemed to be minor in nature, it may be incorporated into the 'as fitted' or 'as laid' drawings.

We do however reserve the right to charge you for any costs incurred directly or indirectly as a consequence of a change to the site or building layout which is deemed to be major. Whether a change is deemed to be minor or major will be at our sole discretion acting reasonably.

GTC Technical Guidelines

Information Requirements

The Fibre Network will be installed and made live a minimum of 20 weeks from acceptance of the GTC offer and receipt of all required minimum information needed to complete fibre design and plan all required works, this information includes:

1. CAD designs of the development (in .dwg format) with plot numbers, details of the site boundary with any planned S278 works clearly marked.
2. Details of any pre-planned service strips.
3. A clear indication of where the fibre network entry point will be for each home.
4. In addition, where the development is a Multi Dwelling Unit (MDU):
5. Details should be provided on the location of the internal communications room that can be used to house telecommunications apparatus with details of all tray work leading to the riser locations.
6. Floor plans will also need to be provided with plot numbers and details of the riser locations. Details should also be provided in each apartment detailing where the fibre should terminate and where the ONT can be located.

Minimum Notice Requirements

Once we have received your acceptance of the GTC offer with the minimum required information we will require the following minimum notice periods for completion of our Works:

- 4 weeks to complete the Fibre network design
- Once you have completed all required On Site Convergence Point (OSCP) construction activities we will require a further 10 weeks to complete all required connectivity installation works and commission and test our telecommunications equipment. No customer connections can be made until these activities are completed.
- 8 weeks for Equipment and/or Installation Materials ordering and delivery to Site. It should be noted that this includes the equipment located within premises.
- 2 weeks for commissioning of an installed system within an individual premise from date of call off by you (further information on this can be found in section 9 of this document).

The contract between us assumes that we will be asked to connect not less than three individual premises per visit to the Project where we are required to perform the Works.

Supply & Storage of Equipment and/or Installation Materials

Equipment and/or Installation Materials will be made available to you in accordance with the Programme of Works.

You are required to provide a secure storage area for any Equipment and/or Installation Materials required to complete the Works.

Any Equipment and/or Installation Materials provided to you for the Works will incur a charge for replacement in the event they are lost, damaged or stolen.

Excessive or unreasonable use of Equipment and/or Installation Materials will also incur a charge.

GTC Technical Guidelines

Client Works

Client Works must be completed to the standard of a Reasonable and Prudent Operator. Client Works are further detailed in the remainder of this Technical Standard document.

Quality of Works

At periodic intervals during the Programme of Works we will carry out routine quality checks.

Any identified Works not completed in accordance with the contract between us will be reported to you. You will be required to make good any identified deficiencies in the Works at your own expense. We will not be responsible for any delay to the Programme that these re-works may cause.

Further details of the Works you are required to perform are set out through the remainder of this Technical Standard document, and the requirements detailed take precedence over the NJUG document.

Section Five

On Site Convergence Point (OSCP) Responsibilities and Requirements

OSCP Definition

The 'On Site Convergence Point' ('OSCP') is the name assigned to the building, street side cabinet or room, together with the collection of equipment placed within it, which is required to enable provision of fibre services to your site. It is your responsibility to provide a suitable OSCP building or plinth that can be used to support the installation of the OSCP type which GTC need to deploy, in order to support your project.

GTC will advise the option that is most appropriate for your project and agree the location of the building, street side cabinet or room as required, at the pre-start meeting.

Requirements for OSCP Building/Room

Exact requirements will be agreed at the pre-start meeting. However, you will be required to construct and for our permanent use and ownership an OSCP building or room which meets the minimum specification requirements of the OFNL standard design and is compliant with all appropriate requirements of the Building Regulations Parts A to P (including amendments to the Approved Documents).

The minimum specification for the OFNL standard design, capable of servicing up to 6000 plots, is shown in Table 1 below.

This is to be read in conjunction with the OFNL standard layout drawings for an OSCP. These can be obtained from your GTC Account Manager or Fibre Project Manager.

Should you be unable to fulfil any of the listed requirements you must notify us at the earliest opportunity, but in any event prior to the pre-start meeting. If your development has over 6000 plots GTC will consider a bespoke OSCP design to cater for your specific needs.

GTC Technical Guidelines

Duct Entry in to the OSCP Building

All OSCP buildings shall have up to six 96.5mm ducts installed to provide distribution and backhaul cabling requirements. Duct segregation is needed between the incoming backhaul cables and the outgoing distribution cables at all times.

OSCP Building Multi-services Chamber

The OSCP multi-services chamber is a FW-4 chamber located directly outside the OSCP or on the footway closest to the OSCP location. This chamber is used to merge all incoming and outgoing cables from the OSCP into the six 96.5mm ducts that directly enter the OSCP from this chamber.

GTC Technical Guidelines

Item requirements	Requirements
Min Internal Dimensions (LxWxH to ceiling soffit)	2400x1600x2800mm
Access	Vehicular access is required within 5m of door with a level access route.
Doors / Locks	<p>OSCP heavy double doors shall be minimum 1500mm wide and 1800mm in height. All doors shall open outwards.</p> <p>The doors shall comprise double skinned GRP or Steel leaves, pre-hung in a suitable robust frame. The doors must be weather tight and with provision for a padlockable handle.</p> <p>Use of the Sunray heavy door (without louvers) is recommended installed with the Sunray 3-point lock system and padlockable handle.</p> <p>For an internal OSCP, located within a building, use Sunray Door type S from the "Sunray Special Firelock 4hr Range" with Structural Opening 760x2070 fitted with external lock hasp and staple.</p>
OSCP "meet me" Ducts and Chambers	1 x FW4 chamber in standard positions outside the OSCP. The FW4 shall have up to 6 x 96.5mm ducts into the OSCP. Site specific details to be provided in the OFNL fibre design.
Duct / Chambers for Offsite Connection route	1x FW4 chamber at edge of site connected to the FW4 at the OSCP via 1nr 96.5mm duct. Site specific details to be provided in your fibre design.
Room Internal Finishes	Floors: Chemical Resistant Anti Slip Floor Paint, Light Grey. Walls and Ceiling: Vinyl Matt Emulsion, Off White. Woodwork: Gloss or Satin, Brilliant White.
Mains Power Connection	230v 100A single phase metered supply.
Distribution Board	Distribution board to be capable of 3 phase use, but fitted for single phase, 100A Mains Switch, 63A RCD.
Socket Outlets	<p>One 63A Commando wall mounted socket fitted adjacent to Rack 1. GTC Project Manager can provide guidance on location discussed at your pre-start meeting.</p> <p>Minimum of 4x twin 13A surface mounted switched outlets.</p> <p>All wiring will be contained in 20mm high impact PVC conduit all switches and wiring accessories will be high impact, non-metallic and fully insulated and sourced from a quality manufacturer.</p>
Lighting	Minimum of 2x 4' twin anti-corrosive polycarbonate switch start units with 2x36W lamps.
Heating	1x 3kW wall mounted Dimplex WFC3NS fan convector heater with inbuilt thermostat and frost protection setting.
Equipment Earthing	<p>6-way earth bar, with single disconnecting link, connected to independent earth rod or integrated to building earthing system as appropriate.</p> <p>There are specific earthing requirements for OSCP cabinets located next to substations and combined OSCP and substation buildings. For combined substation buildings the LV supply is to be provided using a Series 6 cut-out providing a separate Neutral & Earth. The earth will be provided as a separate connection from the substation earth. Please consult the relevant drawing for more information.</p>
Equipment Environmental Conditioning	This may be required in some specific circumstances; a precise specification will be agreed with you at design stage if this is necessary.
Building Alarms	OFNL install alarm and monitoring equipment. Where appropriate though, integration to building Smoke and Fire Systems will be agreed with you at design stage.

Table 1 – OSCP build requirements matrix (standard design up to 6000 plots)

GTC Technical Guidelines

Requirements for OSCP Street Side Cabinet – Developments up to 840 Plots

A street side cabinet deployment can be used to support developments of up to 840 plots. The cabinet is delivered prewired ready with all active and passive equipment to support voice and data services and will be installed by GTC. You will be responsible for building the appropriate plinth and ensuring a suitable single-phase LV feed is provided to the cabinet once in place.

If FIRS is a requirement on the site, then GTC will need to deploy an additional expansion bay onto the standard cabinet. This configuration has a separate plinth requirement.

The street side cabinet has a series of duct entry points for power, earth and fibre cable routes into the onsite network. The expansion bay has a duct entry point for satellite and terrestrial TV signal cables.

Positioning of the Fibre Cabinet

Cabinet positioning is determined by the fibre design.

When planning the installation of a fibre cabinet the site position needs to be checked for the following considerations:

There is 96.5mm clearance between the rear of the cabinet shell (50mm from standard base) and any fixed structure to allow cabinet shell maintenance.

There is sufficient clearance around and above the completed base to allow the cabinet shell to be lowered into position using a mechanical hoist.

Once the cabinet shell is in place all the doors must be able to open a minimum of 90°.

There is a minimum width of 1.2m footway available from the front of the cabinet shell to the roadside edge of the kerb to allow pedestrian access around the fibre cabinet.

Where possible the cabinet is not sited where it would be vulnerable to damage e.g. close to the kerb edge rather than at the rear of the footpath.

Plinth Excavation

Caution: Avoidance of Underground Services: A Cable Avoidance Tool (C.A.T.) and Genny must be used to determine the presence of underground services in accordance with HS(G)47.

Plinth Designs & Construction

Where it has been agreed that a street side cabinet can be deployed you will be required to build the required plinth to support the cabinet installation.

There are two plinth designs, the first supports the standard voice and data cabinet where no FIRS is required and the second supports a voice and data cabinet with the required expansion bay needed to support the additional FIRS equipment.

The plinth should be at least 550mm in depth, this should be constructed using 250mm deep Grade 32/40 concrete top sat on top of a 200mm deep dry compact sub base which should be installed on a 100mm bed of sand.

Specific details on Plinth dimensions can be found in Appendix C.

GTC Technical Guidelines

Street Side Cabinet Electricity Supply

You will be responsible for delivering a single phase LV supply to the cabinet that is capable of supporting a load of 1KWatt. If the cabinet is located next to a substation then the LV supply is to be provided using a Series 6 cut-out providing a separate Neutral & Earth. The earth will be provided as a separate connection from the substation earth. The cabinet will be bonded to the substation earth mat. Please refer to the GTC Project Manager and consult relevant electrical design drawings for more information.

All electrical works are to be carried out in accordance with BS7671.

All cable ties to be cut level leaving no sharp edges.

All metal work and racks within the cabinet are to be earthed. Where the fibre cabinet is located next to an Electricity substation the cabinet should be deployed within the boundaries of the substation's earth mat and must be connected to the substation earth.

Deployment of a cabinet within a 10-metre radius of a substation should be referred back to the GTC Project Manager so the specific earthing requirements can be defined.

Cabinet Earth Rod Installation

A hole is to be excavated to accommodate the earth rod in the appropriate template position to a depth of 1.5m, ensuring that no services are visible within the located area.

The rod is to be installed in the hole, which is then backfilled and compacted.

Please note the use of conductive concrete maybe used in place of an earth rod arrangement.

Earth Readings at Plinth Build Stage

The earth testing must be carried out to appropriate standards and the results must be recorded within the job pack and verified correct by the signature of the person who has the overall responsibility for ensuring the testing has been accurately carried out.

Earth readings for conductive concrete are not taken at the plinth build stage.

Earth readings on earth rods at plinth build stage must be between zero (0) and one hundred and thirty (130) ohms with the following stipulations in place:

If the initial earth reading is 0 to 130 ohms with 1 rod provided in plinth that is acceptable

If the initial earth reading is above 130 ohms then the following additional secondary earth systems should be gradually provided until 0 to 130 ohms is obtained: 2 external rods, 15m of earth tape and up to 3 earth mats (with Programme Manager approval)

If 0 to 130 ohms cannot be obtained using the combination of the secondary earth options, the job should be referred to the region for a decision on cabinet positioning and provision.

The above criteria apply at the Civils earth electrode test stage.

Section Six

Ducting Requirements

Prior to the beginning of Works on site, a pre-start meeting will be arranged by GTC with all parties that are expected to direct installation of OFNL materials. A pre-start checklist and where applicable, a schedule of additional information requirements form, will be completed.

The Developer is responsible for the on-site requirements detailed below:

General Requirements

- Build and prepare either a brick building or street cabinet plinth suitable to house the OSCP in as described in Section 5 of this document.
- Carry out all necessary excavation and backfilling work needed for the installation of fibre mains duct work across the site
GTC will install all required 96.5mm mains duct network within the footway
- Carry out the construction of all required road crossings
GTC will supply required materials
- Carry out the installation of a fibre 54mm lead-in duct from the footway where the 96.5mm mains duct network is installed to the side of each plot and complete all final plot preparations.
GTC will supply required materials
- Maintain an obstacle free route to allow installation work to be carried out in one visit by GTC wherever possible.
- Build any requested chambers, typically these will be brick chambers required to be installed within the carriageway
GTC will provide chamber specifications and free issue suitable ductile covers.
- Build all required chamber bases as per the GTC fibre design in accordance to the specification set out in this document.
- Finishing of all chambers ensuring the final installation is at the required level to the ground surface
- Ensure no work is carried out beneath scaffolding.

See Appendix A for a summary of responsibilities.

GTC Technical Guidelines

Fibre Mains Duct Work

It is essential that the Developer agrees a programme of construction which will enable GTC to co-ordinate fibre mains cable laying activities, within our set timescales.

A site visit will be arranged at the start of your development with GTC staff nominated to construct the network for your development.

GTC will co-ordinate all on-site works and will be the main point of contact for site operations.

GTC Field Engineers will also attend site to ensure that the work is being constructed to an acceptable standard and to meet your requirements.

The Developer is responsible for all excavations; building required chambers or chamber bases, and backfill work on site, unless otherwise requested at the quotation stage.

On request, GTC will normally arrange for the on-site fibre ducts and mains to be laid within 10 working days, in trenches and/or ducts provided by the Developer. Ensure kerb braces have been installed prior to requesting work.

See Appendix A for a summary of responsibilities

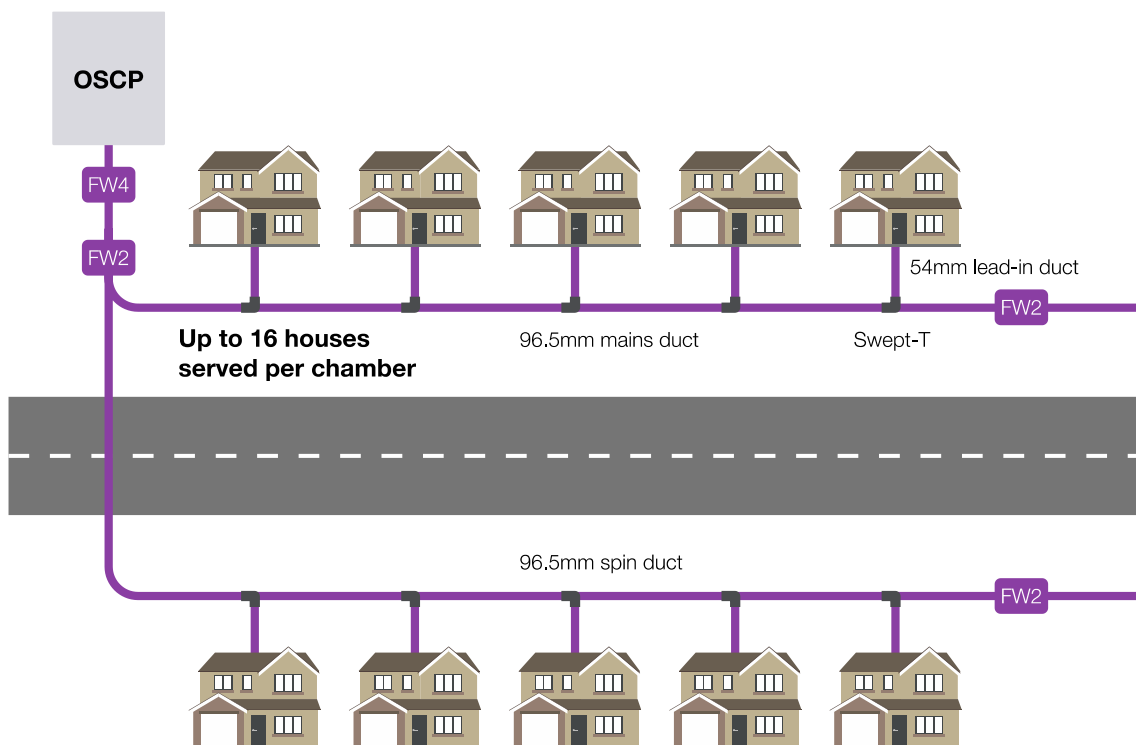

Figure 4 – Overview of GTC Fibre Plant

IN EXCEPTIONAL CIRCUMSTANCES ONLY where the above is not practical or reasonable and with the express written permission of the Construction Director or Fibre Director, GTC may accept a site-specific indemnity letter signed by the Developer accepting a “line and level” approach. In such circumstances the Developer will be indemnifying GTC against any and all costs relating to future relocation of cables and/or damage repairs.

If there are any alterations or deviations to the agreed site layout, which may affect the route of the fibre cables, then GTC must be advised immediately.

GTC Technical Guidelines

Footway Trenching Requirements

Excavate a trench with a width suitable of supporting up to three GTC utilities, your GTC Project Manager will be able to advise exact requirements during the pre-start meeting. The trench should be at least 750mm in depth which will be required for GTC to install all onsite fibre mains ducting and fibre service cables as well as the GTC gas and electricity infrastructure as required. The bottom of the trench should be trimmed to enable the cables to be bedded evenly and consistently throughout the trench, at the correct cover. Sharp stones must be excluded from the base of the trench.

The trench bottom should have at least a 75mm bed of compacted fine material e.g. sand or stone dust.

Road Crossing Ducts

Only fibre ducting, supplied by GTC, should be used for perpendicular road crossings where marked up on the supplied fibre design drawing. Ducting supplied will be manufactured from purple un-plasticised polyvinylchloride (uPVC) in accordance with BSEN 61386 and tested in accordance with BSEN 50086-2-4 (450n compressive strength).

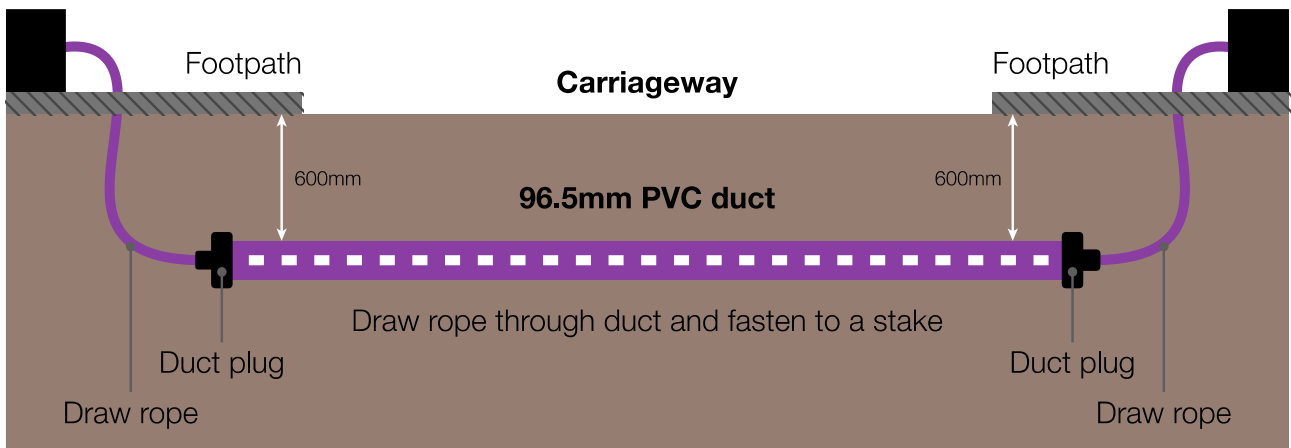

Figure 5 – Fibre road crossing

GTC Technical Guidelines

Backfill Materials

The Developer must ensure that the fibre ducting is surrounded by fine material e.g. sand or stone dust. This will be built up to 150mm above the fibre duct and laid immediately after installation so as to avoid damage.

All backfill and sub-base materials must be free from any organic, perishable or hazardous material.

Green 'Caution - Fibre Optic Cables Below' marker tape, supplied by GTC, should always be installed on top of the cable sand at a depth of 240mm below finished ground level and above the fibre duct/cable before further backfilling the trench.

GTC will work with the Developer to ensure that the fibre duct sand surround and marker tape is installed to our specifications as shown below:

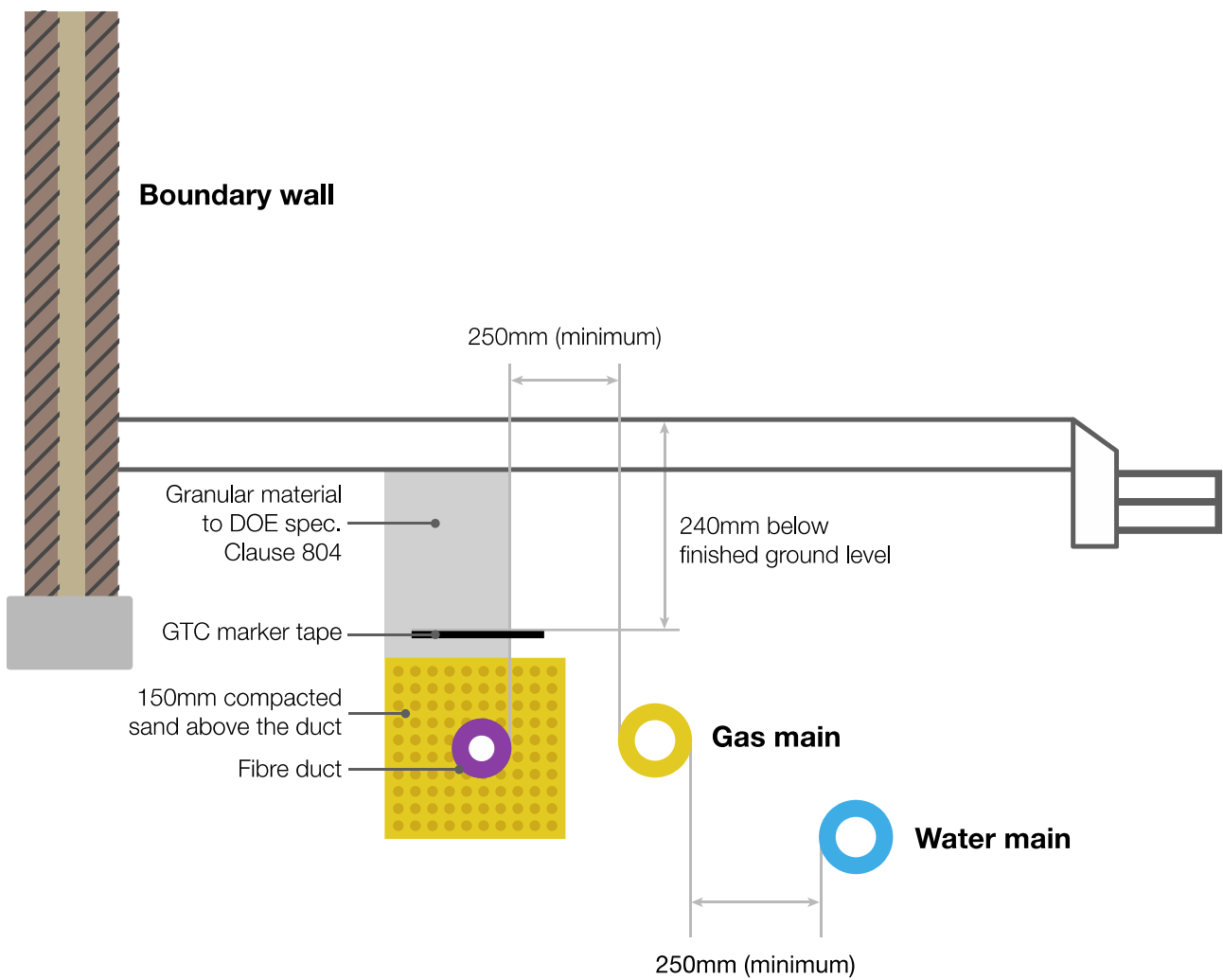

Figure 6 – Fibre backfill

GTC Technical Guidelines

Individual Plot Service Ducts

All fibre service cables used to connect plots will run from the footway to the side of building and must be ducted using a 54mm purple duct supplied by GTC. The 54mm purple duct must be laid at a minimum depth of 350mm in a straight line along a route as shown on the agreed network drawings, any deviations must be agreed with GTC, prior to installing the fibre service. The route should be perpendicular to the property and take the shortest route possible to the building entry point from the fibre services connection point in the footway.

You should lay green 'Caution - Fibre Optic Cables Below' marker tape, supplied by GTC, on top of the cable sand at a depth of 240mm below finished ground level and above the fibre duct/cable before further backfilling the trench.

You will need to install purple pre-formed 90-degree bend, supplied by GTC, between the end of the 54mm service duct and below the service entry point for the plot. The 54mm purple duct will be brought to a vertical termination by means of the pre-formed 90-degree bend on the external wall. The services duct must be cut 50mm above ground level and directly below the service entry point hole for the plot:

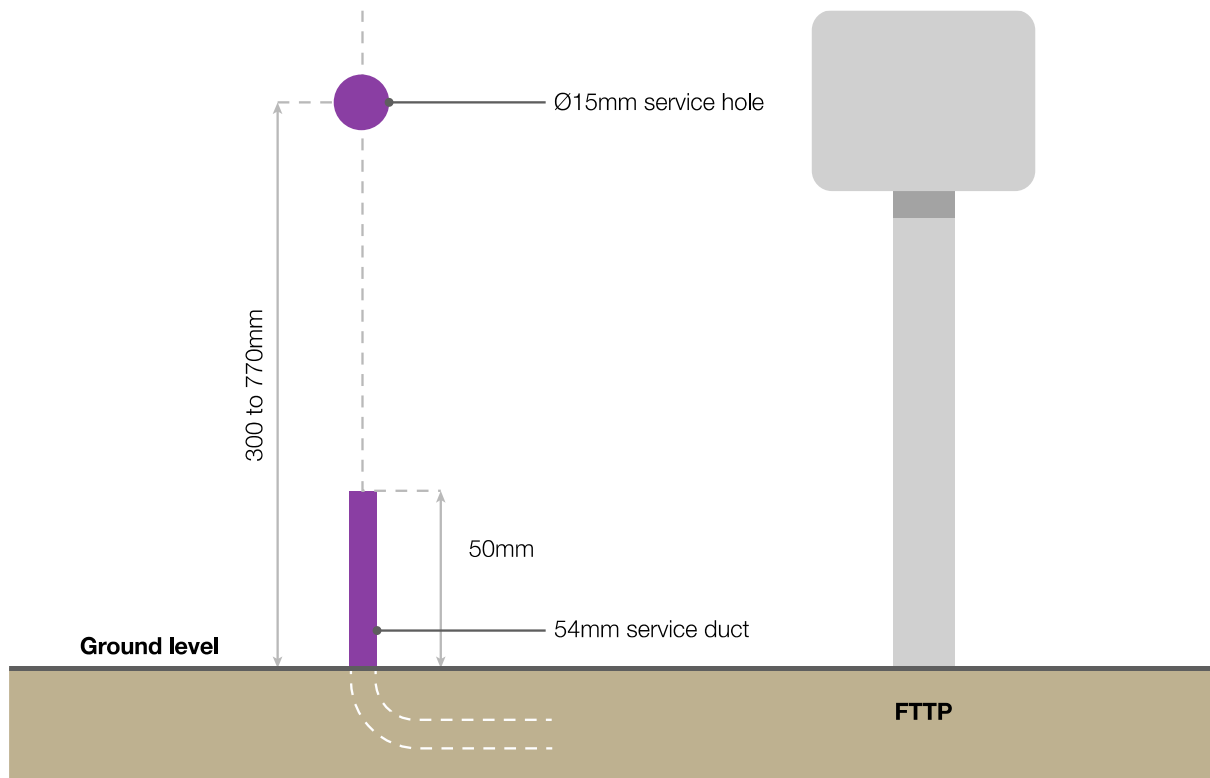

Figure 7 – Service ducts

GTC Technical Guidelines

You are responsible for ensuring that all groundworkers installing fibre service duct are shown and fully understand the GTC Service Installation Video. The video is accessed using a QR code (below) which will be issued to the Site Manager/Agent by the GTC Project Manager at the pre-start meeting. An up-to-date register of those individuals installing fibre service duct should be recorded in Appendix D and kept by the Site Manager/Agent.



Use QR Code to access the *Groundworkers Guide to Service Pipe and Duct Installation* video.

Plot Entry

You will supply and install a standard 15mm conduit through the cavity wall at the point that is vertically above the end of the service duct. External Connector Bend 4 and where required Capping 25A will be supplied and fitted by GTC.

GTC Technical Guidelines

The default location for the ONT, supplied by GTC, will be mounted on the internal wall adjacent to the external wall entry:

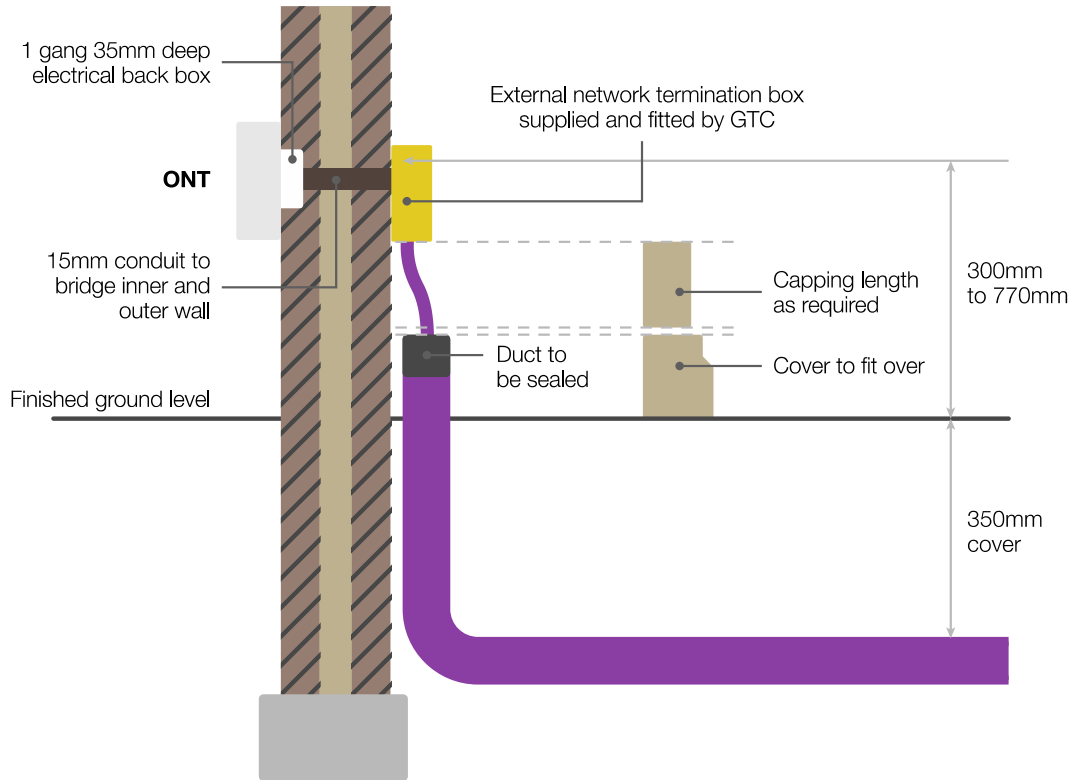

Figure 8 – External wall entry

Where it is not possible to install the ONT on an internal wall adjacent to the external wall entry you may deploy the ONT in a more convenient location within the property. GTC will free issue a Micro Duct that you will need to install from the external entry point to a point up to 15 metres away. Where deployed the Micro Duct must be installed in one contiguous fault-free length.

Easements

GTC requires legal rights over all its equipment (i.e. Onsite Convergence Point and fibre cable) to secure future ownership and maintenance abilities which are imperative to the continued supply of fibre services. Where this equipment is to remain within private land, GTC will need to obtain its rights from the Developer (or landowner if different).

To ensure these consents are completed efficiently and at the earliest opportunity, the Developer (or landowner if different) should assist with the following:

- Ensure their legal representative is instructed to act upon acceptance of the project.
- Ensure their legal representative responds to all correspondence received from GTC's legal representative without delay.
- Immediately advise GTC of any changes that may affect the legal acquisitions (i.e. change in current ownership).

The timescale of consent acquisitions for a project are of great importance as they may affect required energisation dates if not completed in good time.

GTC Technical Guidelines

Materials Delivery and Handling

- Ducting, chamber rings, chamber lids and frames, fibre cable and associated equipment will be delivered directly to site and must be visually inspected on delivery and any damage immediately reported to GTC.
- Materials must be carefully stored in a safe and secure area on dry, firm and level ground.
- Any loss or damage occurring after delivery will be chargeable to the Developer.

Ground Workers

All installed fibre apparatus MUST be treated as live.

- Any injury, damage to plant, however slight, must be notified to the Asset Owner and Site Manager immediately.
- Damage to fibre ducts and cables can result in loss of service on the development. This will result in homeowners not being able to access emergency services via the fixed line phone services.
- Damage can result from excavation or penetration of the ground (e.g. by a road pin).
- Underground services may be commonly found in roads, footpaths and on sites or across open land.
- Make sure you have plans of the underground services in the area and make use of them. This may not always be possible for emergency or unforeseen works. Remember that service connection cables from the mains to a building may not be shown.
- Use approved techniques to confirm the position of fibre ducts and cables, metal pipes and any other detectable plant within and around the area of proposed excavation.
- Look for signs of service connection cables or pipes, e.g. gas, electricity, fibre or water meter boxes, valve covers, chamber lids or a service connection entry into a house or streetlamp.
- Hand dig trial holes (as many as necessary), to confirm the exact position of services in close proximity to the area of your work. This is particularly important if there are plastic pipes which cannot always be found by electro-magnetic location techniques

Services are sometimes protected by concrete, polythene or earthenware tiles or a marker tape laid above the service - this is a useful indication of the presence of the service; you should avoid disturbing any tile or tape to expose the service if possible.

Do not use existing buried plant as a step to enter or exit any excavation.

Section Seven

Chamber Requirements

GTC will provide a Duct and Chamber design with 4 weeks of receiving acceptance of the GTC Fibre offer and all the required minimum information. The Duct and Chamber design will include:

- All onsite chamber locations and types
- Ducts from OSCP to associated chambers
- Ducts from distribution chamber to homes including swept-Ts
- Location of an edge of site chamber for external services
- Duct requirement from edge of site chamber to defined OSCP Chamber

You may be required to build Chambers at specific locations as per the provided design, your GTC Fibre Project Manager will be able to advise where these will be required. GTC will provide you with the required chamber rings, frames and lids needed to construct these chambers.

Where it is not possible to do so you should request a design change request to the GTC Fibre Designer or GTC Fibre Project Manager.

Chamber Construction

The GTC's preferred method for chamber construction is to use pre-formed modular chambers constructed in ring sections that are stacked on top of each other.

This deployment methodology provides a deskilled, fast-track method of construction which does away with the need for specialist box building teams and concrete backfill. Complete chambers can be constructed from excavation to reinstatement in little more than an hour.

A minimum of four full sections are to be installed on top of the compact type 1 or concrete base to maintain the required 600mm depth.

Compact the material in the base of the excavation and install a concrete base (C20 or dry mix) or compact type 1 base that is 150mm deep. A sump of 100mm diameter, and 100mm deep is to be provided in each concrete base to enable chambers to be pumped dry. A 25mm raised bead of concrete will provide additional bedding support in heavily loaded environments or where the chamber might be loaded before the base is fully cured.

GTC Technical Guidelines

Where chambers are to be installed in the carriageway a 200mm deep chamber base is required constructed either using a BS12 Portland Cement or Grade 32/40 concrete, reinforced with A393 grade mesh at 70mm cover.

All Footway chambers are to be of modular construction where possible. A minimum chamber depth of 600mm above the concrete base is to be maintained at all locations to enable the installation of fibre equipment and service loops.

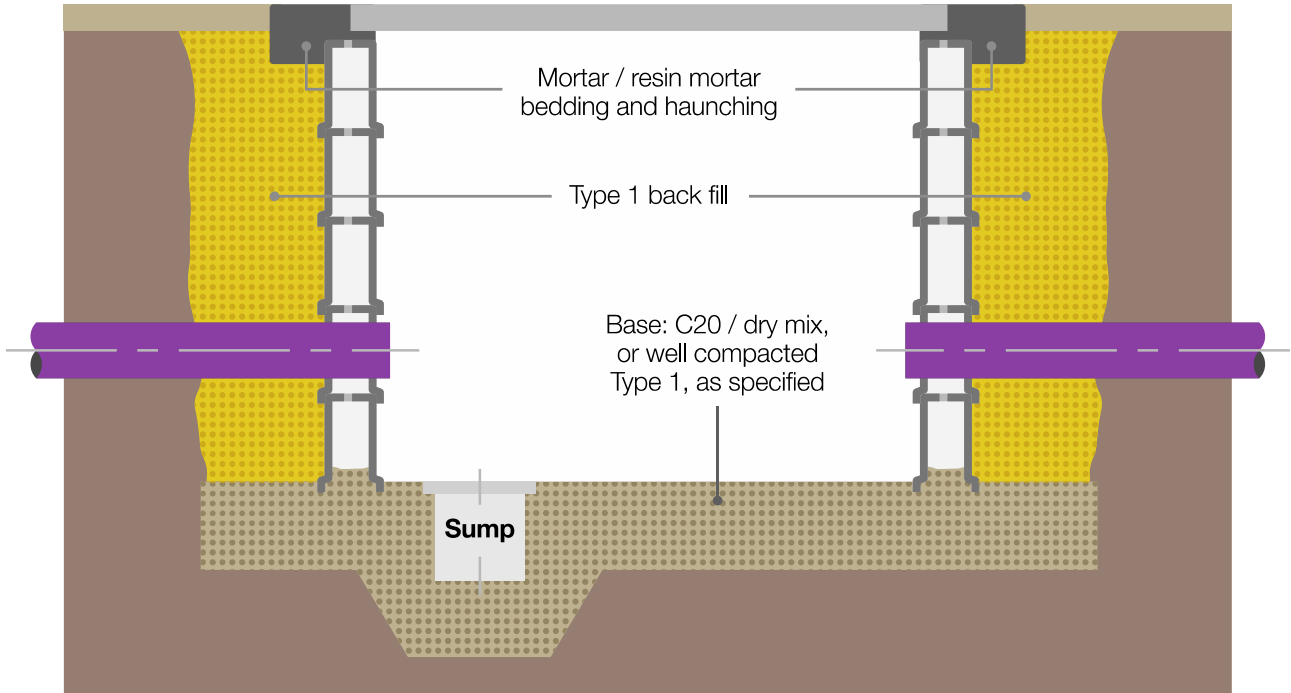

Figure 9 – Chamber construction

Required Minimum Chamber Depths

When constructing a chamber please do so in accordance with the manufacturer’s instructions.

Ducts shall not enter chambers closer than 75mm to any corner, at a minimum of 350mm depth (measured from cover level), and with a vertical level of not less than 100mm above the chamber base slab. Duct entries are to be cut flush with the chamber walls and rasped to remove rough edges.

* Standard depth of chamber from the base to the underside of the cover

Type of Chamber	Surface Type	Depth *	
		Standard (mm)	In close proximity of Carriageway with Road crossing (mm)
FW2/JMF 102 (725mm x 225mm)	Verge / Footway	600	600
FW4/JMF 104 (915mm x 455mm)	Verge / Footway	600	600
CW12 (1220mm x 685mm)	Carriageway	900	900

Table 2 – types of chambers and the required standard depths

GTC Technical Guidelines

Locations of Chamber

As part of fibre mains duct and cable installation process GTC will build required chambers along the designated fibre route as per the agreed design.

On occasions, you will be required to build specific Chambers at specific locations required to support the GTC installation activities. Your GTC Fibre Project Manager will be able to advise where these will be required. GTC will provide you with the required chamber rings, frames and lids needed to construct these chambers.

Frames and Covers

For grass verges and similar areas, the frame can be fitted directly onto the top surface of the modular chamber but should be secured with a 200mm wide mortar haunching at least 100mm deep.

Where the frame must be completely rigid, such as in the pedestrian areas, the frame should be bedded on a layer of mortar (maximum depth 50mm) and the surround made good back to solid paving material.



FW4 Chamber in Footway

A resin mortar should be used if the cover is likely to encounter vehicular loads, or where the installation is likely to be disturbed before conventional mortar has cured.

When installing a chamber in the carriageway a ductile Frame and Cover Carriageway no.2 is to be installed squarely set on a on a mortar bed that is Highway Agency standards HA104.



Figure 10 – FW-4 chamber lid and frame



Figure 11 – CW-12 ductile cover

GTC Technical Guidelines

Cleaning

All Chambers shall be thoroughly cleaned, and all debris removed on completion of construction.

Completing Chamber Installation to Required Surface Level

You are responsible of ensuring all chamber installations across the development are completed to the required ground surface levels.

If the frame requires levelling to the ground surface, or to a newly raised surface level, the OFNL rising frame unit provided (as shown below) are available as an option. These should be used in conjunction with resin mortar to build the frame up to the required level.

Riser Frame

If the chamber height has been miscalculated and the levels cannot be altered by adjusting the bedding of the frame, it is possible to cut the top section of the chamber horizontally to correct the level.



Section Eight

MDU Requirements

Multi Dwelling Unit (MDU) Duct Entry

You will install the 96.5mm service duct from the chamber outside the MDU directly in to the MDU building. The 96.5mm service duct is to be installed horizontally below the slab and brought to a vertical termination by means of a pre-formed 90° bend. The termination point will be against the inside face of the wall and cut 50mm above the finished floor level, as illustrated below.

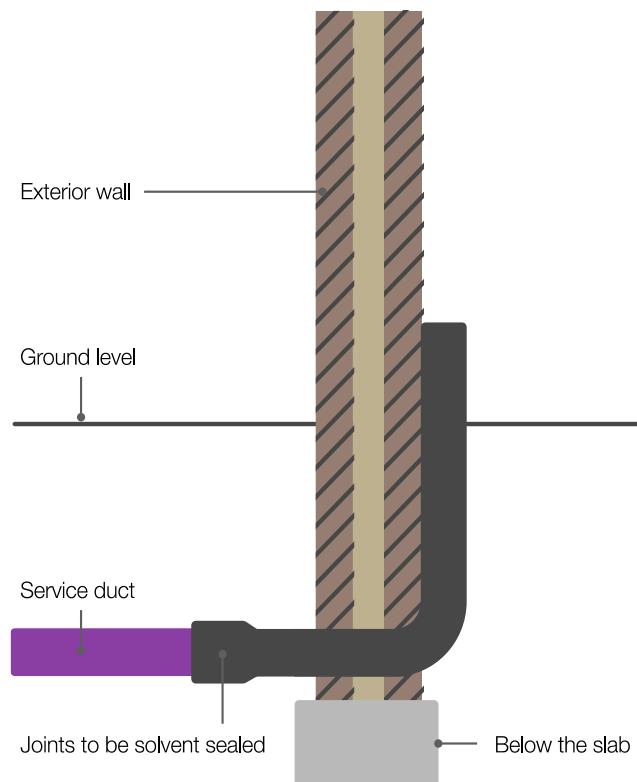

Note: Duct to be 50mm above finished floor level

Figure 11 – MDU entry below the slab

GTC Technical Guidelines

Small MDU – up to 25 Apartments

From the 96.5mm diameter duct entry position you will need to provide and install appropriate tray work from the entry position to and then up the building risers. We will use this tray work to install our fibre cable and MDU riser boxes that are used to provide service to each apartment.

You will also be required to install a free issued micro duct from each apartment to the riser where the allocated MDU-Riser box will be installed; this location will be clearly marked on the fibre design. Two metres of micro duct is required at each end of the installation which should be left coiled.

All micro duct runs must be kink and blockage free, with all open ends temporarily sealed to prevent ingress of moisture or extraneous material. If subsequently a fibre tail cannot be pushed through, we will require the remedial work to be carried out at your expense.

At a suitable and agreed programme window we will install the MDU riser enclosures within the riser as per the fibre design and run the required fibre cables up the riser. Following this we will install and commission the ONT (Optical Network Terminal), prior to occupation by residents.

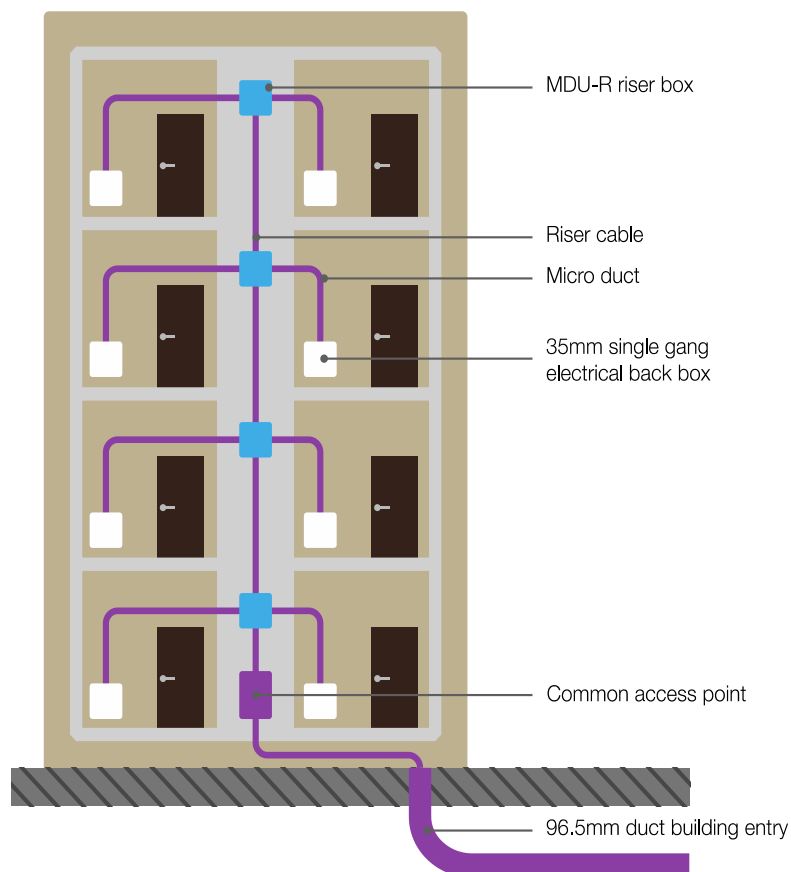

Figure 12 – Small MDU layout

GTC Technical Guidelines

Network Layout (Large MDU)

Larger MDU's tend to differ in layout and dimensions, so a tailored solution will be designed. Principally this solution will consist of a basement or podium level plant comms room, giving access to one or more risers through the building core(s). Where other buildings are to be served these will need to be connected by means of a private duct network which you will install to our design. We will access and own the secured comms room, and it will perform the function of an OSCP, in which we will install various cabinets to house our equipment including Large Distribution Wall Boxes (LDWB) that are used to provide a service to each apartment.

From the comms room you will need to provide and install appropriate tray work from the entry position to and then up the building risers. We will use this tray work to install our fibre cable. You will also be required to install a free issued micro duct from each apartment to the riser where the allocated LDWB will be installed, this location will be clearly marked on the fibre design. Two metres of micro duct is required at each end of the installation which should be left coiled.

All micro duct runs must be kink and blockage free, with all open ends temporarily sealed to prevent ingress of moisture or extraneous material. If subsequently a fibre tail cannot be pushed through, we will require the remedial work to be carried out at your expense.

At a suitable and agreed programme window we will install the LDWB enclosures within the riser as per the fibre design. We will run the required fibre up the risers and where necessary install an Optical Distribution Frame (ODF) where all fibre will terminate, as well as any other active or passive equipment within the comms room located at the basement or podium level. Following this we will install and commission the ONTs, prior to occupation by residents.

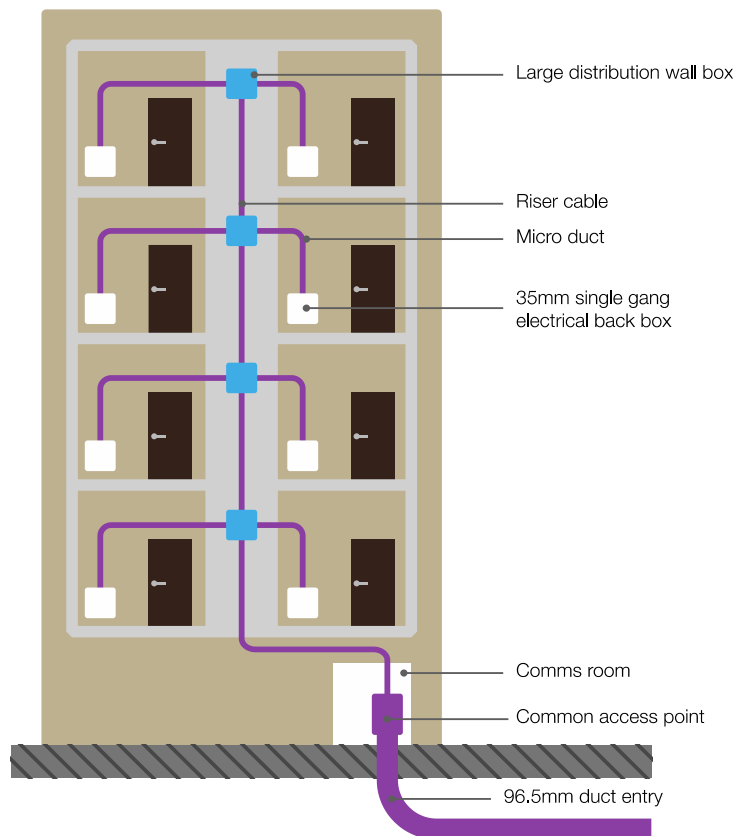

Figure 13 – Large MDU unit

Section Nine

Works at ONT Location and for in Premises Distribution Cabling

We will install the ONT capable of supporting a maximum of one telephone service and one data service.

To facilitate this you will be required, during construction, to install a 35mm 1 gang electrical back box in a suitable and agreed location.

You will also be required to supply and install all necessary, power, telephone and data cabling.

The preferred location for the ONT is in an open area such as close to the lounge TV point. Consideration to potential extremes of temperature or high levels of moisture must also be considered when selecting the ONT location.

The location of the ONT must also give due regard to access for customers with disabilities or mobility problems and for the repair or replacement of faulty or damaged equipment.

The service duct which will carry the incoming fibre cable must also terminate into the electrical back box in the agreed location.

Developer's Obligations

In order to enable us to complete our Works, we will require you to:

- Supply and install a 35mm 1 gang electrical back box to support the ONT installation in a suitable location.
- Supply and install one switched twin socket outlet adjacent to the 35mm 1 gang electrical back box used to support the ONT installation.
- Supply and install all distribution cabling - wall sockets for voice, data and FIRS services (where applicable) around the property and terminate the cabling into sockets adjacent to the 35mm 1 gang electrical back box mentioned above.

All obligations for both GTC and you are summarised in the Responsibility Matrix in Appendix A.

GTC Technical Guidelines

Where the external fibre entry point is not adjacent to the ONT location you will need to ensure the GTC free issued Micro Duct is installed from the external entry point to the ONT Back Box. The Micro Duct should be installed in to the ONT Back Box through one of the circular knock out ports on the rear or side panel of the box. The Micro Duct must be installed in one continuous fault-free length.

Home Wiring and Cable Termination

To give your homeowners maximum benefit of Fibre to the Home technology and the best possible experience, you need to make sure your wiring meets the demands of modern living.

Telephone and Data (where applicable) cabling and sockets must be provided around the home consolidating back at the ONT unit.

Telephone Wiring Specification

A single 631A secondary telephone socket should be located below the ONT. CW1308 4 pair cable should be run from this socket in a series or “daisy-chain” arrangement to further 631A secondary telephone sockets located around the premise.



Figure 14 – 631A secondary telephone socket

631a Telephone Socket	Cable Colours
5	White/blue stripe
3	Orange/white stripe
2	Blue/white stripe

Table 3 – Telephone Wiring

GTC Technical Guidelines

Broadband Wiring Specification

From a RJ45 faceplate located below the ONT run multiple solid core Cat5e cables to suitable locations within the property using a point-to-point data wiring configuration.

Each Cat5e cable should be terminated with a RJ45 faceplate in rooms where broadband services are required and should be located within one metre of a mains power socket.

All cabling for faceplates must be of the solid core variety (as opposed to stranded) in all circumstances. An IDC termination tool should be used to install the solid core Cat5e data cable to the RJ45 socket.

Sockets should be sourced that have TIA/EIA-568B colour coding.



**Figure 15 – Port 1
RJ45 face plate**

GTC Technical Guidelines







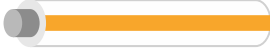

PIN		T568B Colour
	01	White / Orange Stripe
	02	Orange Solid
	03	White / Green Stripe
	04	Blue Solid
	05	White / Blue Stripe
	07	Green Solid
	08	White / Brown Stripe
	08	Brown Solid

Figure 16 – TIA/EIA-568B colour coding

GTC Home Wiring Requirement

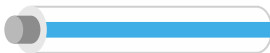
Telephone Wiring

GTC recommend that a single port 631A secondary telephone socket is installed below the ONT which is connected in a “daisy-chain” arrangement using CW1308 4 pair cable to single port 631A secondary telephone sockets located in the Living Room, Bedroom 1, Bedroom 2 or a Study.

Minimum Broadband Wiring

GTC have a mandatory minimum broadband wiring requirement that must be followed to ensure compliance with this technical specification. If the ONT is installed in the Living room next to the TV point, then no additional wiring is required. If the ONT is located within an understairs/utility cupboard or hallway the minimum requirement is a 1 port RJ45 Cat5e faceplate below the ONT which connects to a 1 port RJ45 Cat5e faceplate in the Living Room located within one metre of a power socket and adjacent to the main TV point.

GTC Technical Guidelines

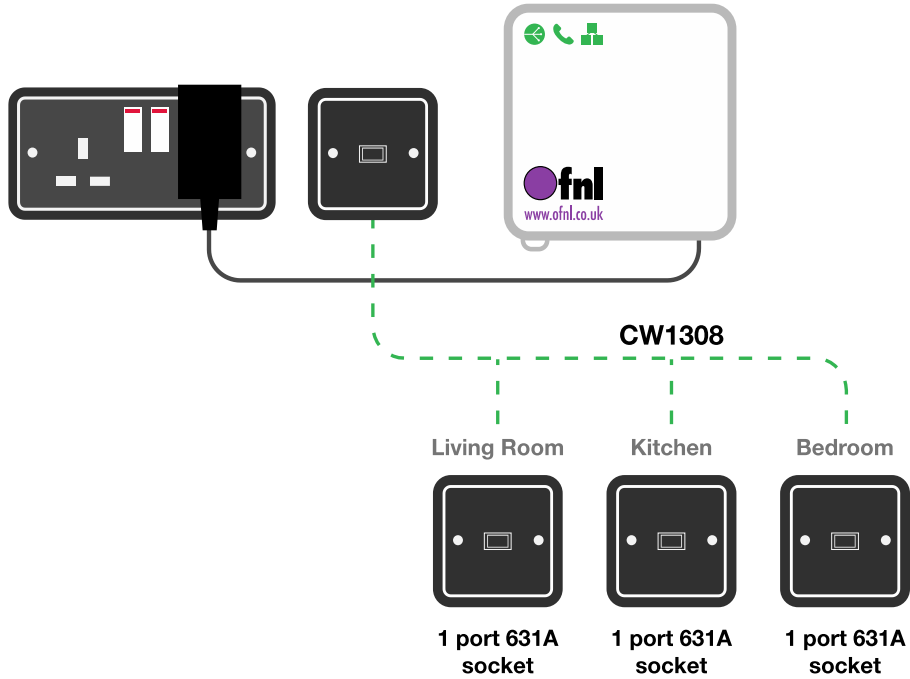

Figure 18 – Minimum home wiring requirement – ONT located within living room

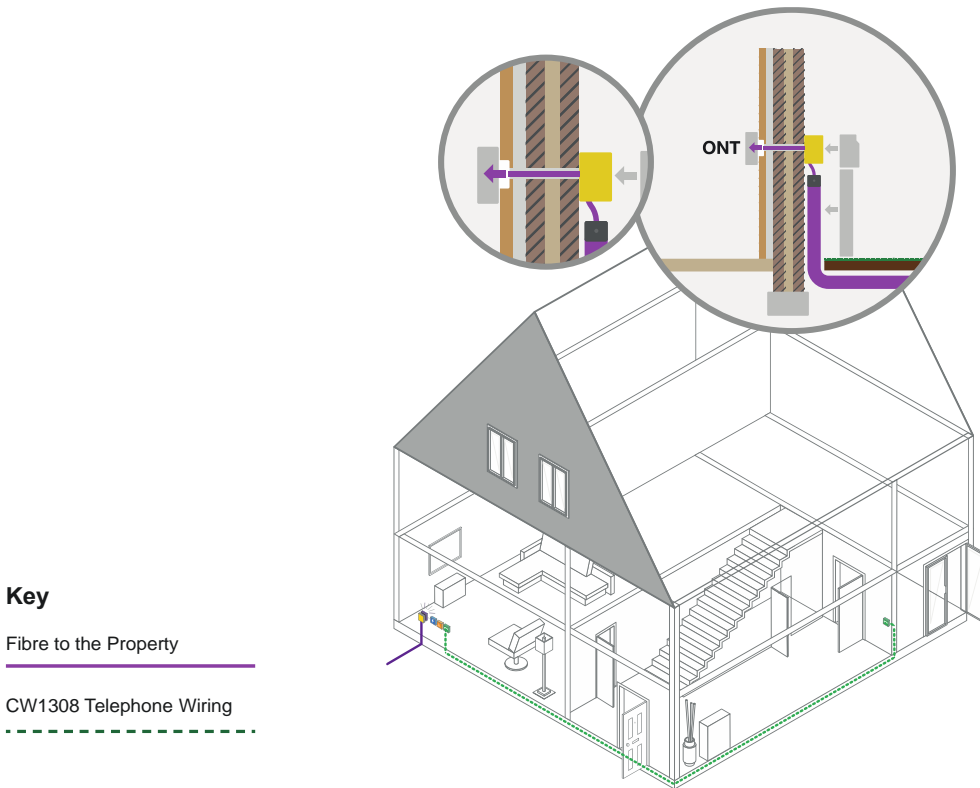

Figure 17 – Typical house layout –

GTC Technical Guidelines

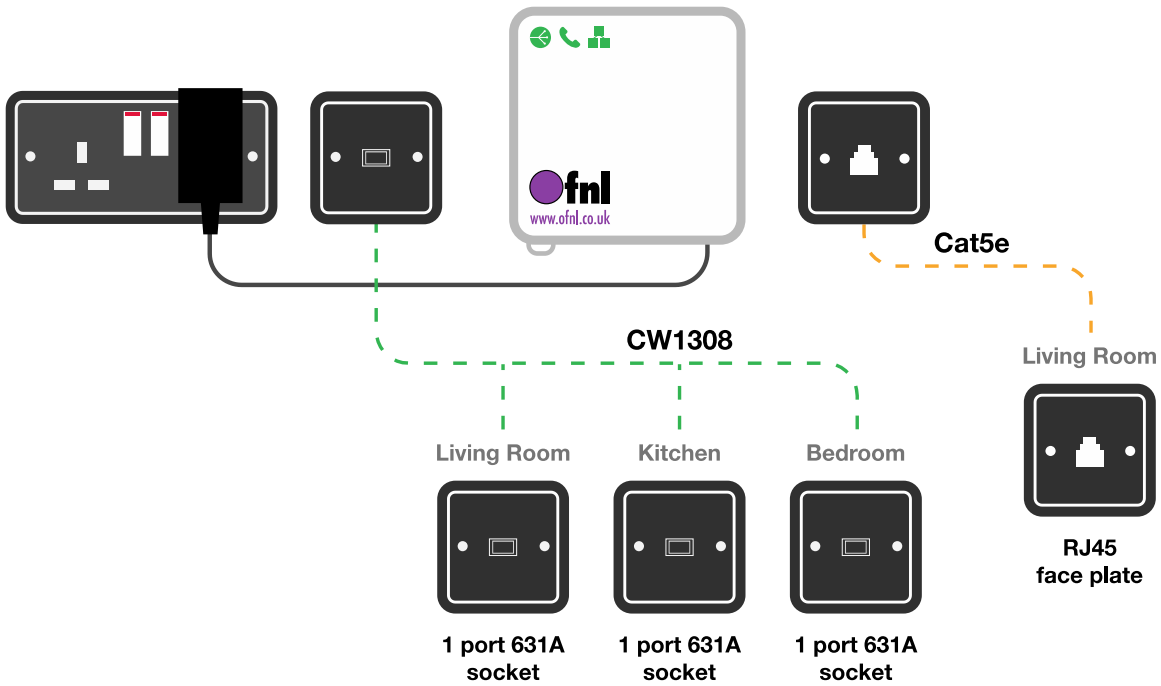

Figure 20 – Minimum home wiring requirement –

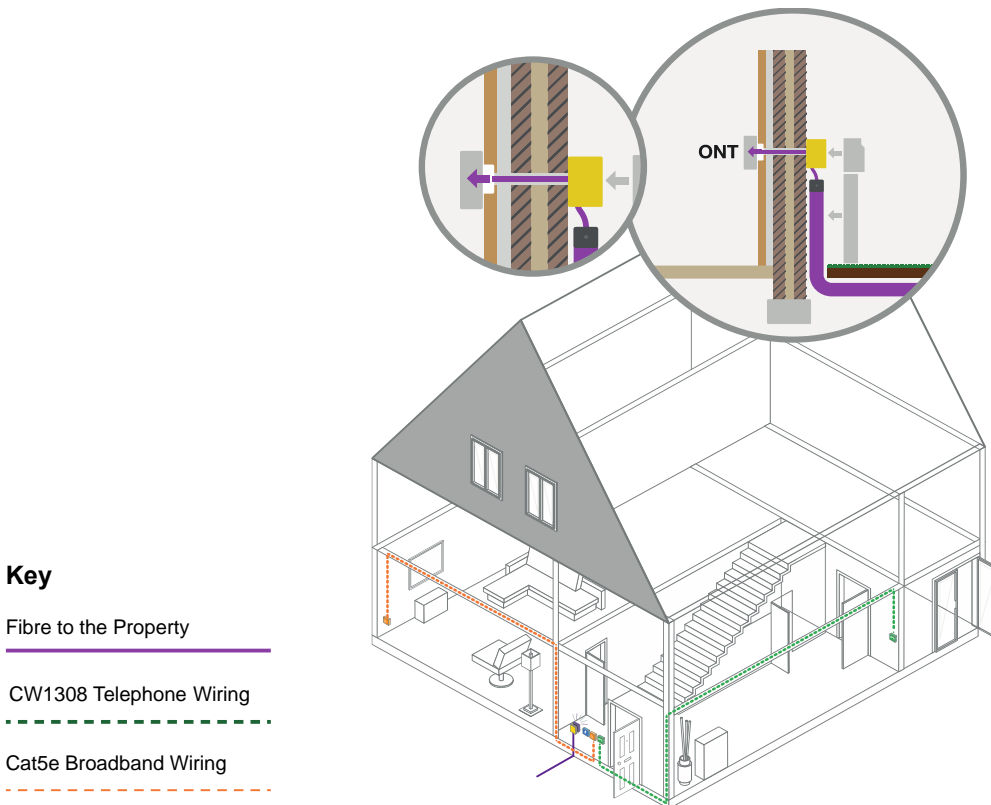

Figure 19 – Typical house layout – ONT located within utility cupboard or hallway

GTC Technical Guidelines

If you wish for your customers to experience an excellent service around their new home, then GTC recommend installing further broadband wiring around the home. For example, rather than installing a 1 port RJ45 Cat5e faceplate in the living room this could be upgraded to a 4 port RJ45 Cat5e faceplate. Port 1 of the 4 port RJ45 Cat5e faceplate can be used to wire back to the ONT installation location, i.e. in the hallway. The additional 3 spare ports could then be used to provide further broadband wiring distribution around the property. For example, Port 2 could be wired to a 1 port RJ45 Cat5e faceplate located in the study, Port 3 could be wired to a 1 port RJ45 Cat5e faceplate located in the kitchen and Port 4 could be wired to a 1 port RJ45 Cat5e faceplate located in the master bedroom. We also have a number of enhanced options to support media plate distribution points. GTC would be happy to discuss further internal broadband wiring options with you.

Summary/Key Points of ONT Installation

- A 35mm deep single gang back box must be installed for GTC to install the ONT.
- A micro duct to be installed from the external fibre entry point to the 35mm deep single gang back box location.
- One twin switched power socket outlet to be provided adjacent to the 35mm deep single gang back box.
- 631A secondary sockets for telephone terminations.
- Telephone cabling is daisy chained from multiple connection points using CW1308 back to a single connection adjacent to the 35mm deep single gang back box.
- RJ45 sockets for data terminations.
- Data cabling is point to point using Cat5e or better
- Remember to label all cables, sockets and connections correctly
- Failure to follow these deployment rules will mean you incur extra time and cost in remedial works.

Section Ten

Testing

Testing of Installed Cable Networks

You are responsible for ensuring that any telephone and broadband wiring you install is tested and that you are satisfied that they are fit for purpose. This wiring is not the responsibility of GTC and any faults before or after customer occupation are your responsibility.

Testing of Installed ONT

Once the ONT has been installed we will perform tests to confirm that the service to the premise is fully operational. End-user telecoms services will be enabled once the customer is contracted. Should this testing reveal any faults with works you have carried out, we will require the appropriate remedial or re-provisioning work to be undertaken before a customer can have services enabled.

Section Eleven

Appendices

GTC Technical Guidelines

Appendix A – Summary of responsibilities

Description	Material Provider	Installer	Applicable to			
			SDU (IRS)	SDU (NO IRS)	MDU (IRS)	MDU (No IRS)
On Site Connection Point						
OSCP/OSCP Plinth Construction / M&E Fit out (As per Section 5)	Dev	Dev	✓	✓	✓	✓
Network Equipment in OSCP	GTC	GTC	✓	✓	✓	✓
External Fibre						
96.5mm diameter duct - road crossings	GTC	Dev	✓	✓	✓	✓
External Chambers as required	Dev	Dev	✓	✓	✓	✓
External Chamber covers and frames	GTC	Dev	✓	✓	✓	✓
96.5mm diameter building entry ducts.	GTC	Dev	✗	✗	✓	✓
54mm diameter service duct	GTC	Dev	✓	✓	✗	✗
Internal Fibre						
Microduct ("drop tubes")	GTC	Dev	✓	✓	✓	✓
ONT						
ONT - 1 Gang 35mm Back Box	Dev	Dev	✓	✓	✓	✓
1x twin switched socket outlets at ONT location	Dev	Dev	✓	✓	✓	✓
ONT (incl FIRS where contracted)	GTC	GTC	✓	✓	✓	✓
Telephone sockets below ONT wired to room sockets	Dev	Dev	✓	✓	✓	✓
Data sockets below ONT wired to room sockets.	Dev	Dev	✓	✓	✓	✓
In Premise Wiring						
Coaxial cable and socket outlets for FIRS distribution.	Dev	Dev	✓	✗	✓	✗
Coaxial cable and socket outlets for non-FIRS distribution.	Dev	Dev	✓	✗	✓	✗
Cat5e (solid core) cable for data and telephony wiring	Dev	Dev	✓	✓	✓	✓
CW1308 cable for telephony wiring (if Cat5e not used)	Dev	Dev	✓	✓	✓	✓
Data sockets (RJ45) at agreed outlet locations	Dev	Dev	✓	✓	✓	✓
Telephony sockets (631a) at agreed outlet locations	Dev	Dev	✓	✓	✓	✓

Table 4 – Summary of responsibilities

GTC Technical Guidelines

Appendix B – Quality

We will undertake quality checks of the Works you undertake for us. Sample Quality Check forms for this are set out below.

Quality checks on the internal wiring specified under Part 3 of this document are at your own discretion as responsibility for this part of the network remains with you.

However, it is nevertheless recommended that the quality of internal wiring components you provide are quality checked by suitably qualified personnel for electrical integrity and layout to ensure they are fit for purpose. We reserve the right to refuse connection of any equipment to internal wiring we believe to be unfit for purpose. In the event that any part of the Works provided or undertaken by you fails to reach an adequate standard and needs replacing, that replacement will be at your cost.

Quality Check Form Sample: Duct and Chamber Construction

Name of Client:

Address:

Post Code:

Project Number:

Sub Project Number:

	Y	N	n/a	Comments
Ducts laid in accordance with relevant requirements, or expectations agreed and documented				
Separation distances maintained, or expectations agreed and documented				
Ducts correctly bedded and sides compacted				
Ducts properly trimmed and keyed when set in walls				
Chambers constructed in accordance with relevant requirements, or expectations agreed and documented				
Frames and covers bedded correctly and fitted level				

THIS CLIENT QUALITY CHECK SHEET CERTIFIES THAT ALL WORK HAS BEEN CARRIED OUT IN ACCORDANCE WITH THE CONTRACT SPECIFICATION OR AGREED ALTERNATIVES.

Site Manager's Name (Print):

Sign:

Date:

GTC Technical Guidelines

Quality Check Form Sample: Standard Building Entry – Adjacent ONT Location

Name of Client:

Address:

Post Code:

Project Number:

Sub Project Number:

	Y	N	n/a	Comments
External Service Duct Terminated directly below 15mm plot entry hole (Standard Building Entry)				
15mm plot entry duct routes to Recessed 35mm deep single gang back box				
Recessed 35mm deep single gang back box in appropriate position and firmly fixed				
Position of power feeds and outlets as per specification				
Voice and data cabling provided and terminated correctly				
All sockets labelled as per requirements				

THIS CLIENT QUALITY CHECK SHEET CERTIFIES THAT ALL WORK HAS BEEN CARRIED OUT IN ACCORDANCE WITH THE CONTRACT SPECIFICATION OR AGREED ALTERNATIVES.

Site Manager's Name (Print):

Sign:

Date:

GTC Technical Guidelines

Quality Check Form Sample: Standard Building Entry – Remote ONT Location

Name of Client:

Address:

Post Code:

Project Number:

Sub Project Number:

	Y	N	n/a	Comments
External Service Duct Terminated directly below 15mm plot entry hole (Standard Building Entry)				
Microduct provision from 15mm plot entry hole to 35mm deep single gang back box is free from obstruction and kinks in one contiguous fault-free length				
Recessed 35mm deep single gang back box in appropriate position and firmly fixed				
Position of power feeds and outlets as per specification				
Voice and data cabling provided and terminated correctly				
All sockets labelled as per requirements				

THIS CLIENT QUALITY CHECK SHEET CERTIFIES THAT ALL WORK HAS BEEN CARRIED OUT IN ACCORDANCE WITH THE CONTRACT SPECIFICATION OR AGREED ALTERNATIVES.

Site Manager's Name (Print):

Sign:

Date:

GTC Technical Guidelines

Quality Check Form Sample: MDU Installation

Name of Client:

Address:

Post Code:

Project Number:

Sub Project Number:

	Y	N	n/a	Comments
External Service Duct Terminated service installed horizontally below the slab and brought to a vertical termination by means of a pre-formed 90° bend. The termination point against the outside face of the wall and cut 50mm above the finished floor level				
Designated tray work in good working order				
Microduct installation is as per GTC design, is free from obstruction and kinks and is in accordance with manufacturer's specifications and IET wiring regulations				
Microduct routes from riser to apartment in one contiguous fault-free length to Recessed 35mm deep single gang back box located in apartment				
Recessed 35mm deep single gang back box in appropriate position and firmly fixed				
Position of power feeds and outlets as per specification				
Voice and data cabling provided and terminated correctly				
All sockets labelled as per requirements				

THIS CLIENT QUALITY CHECK SHEET CERTIFIES THAT ALL WORK HAS BEEN CARRIED OUT IN ACCORDANCE WITH THE CONTRACT SPECIFICATION OR AGREED ALTERNATIVES.

Site Manager's Name (Print):

Sign:

Date:

GTC Technical Guidelines

Appendix C – Plinth construction specification

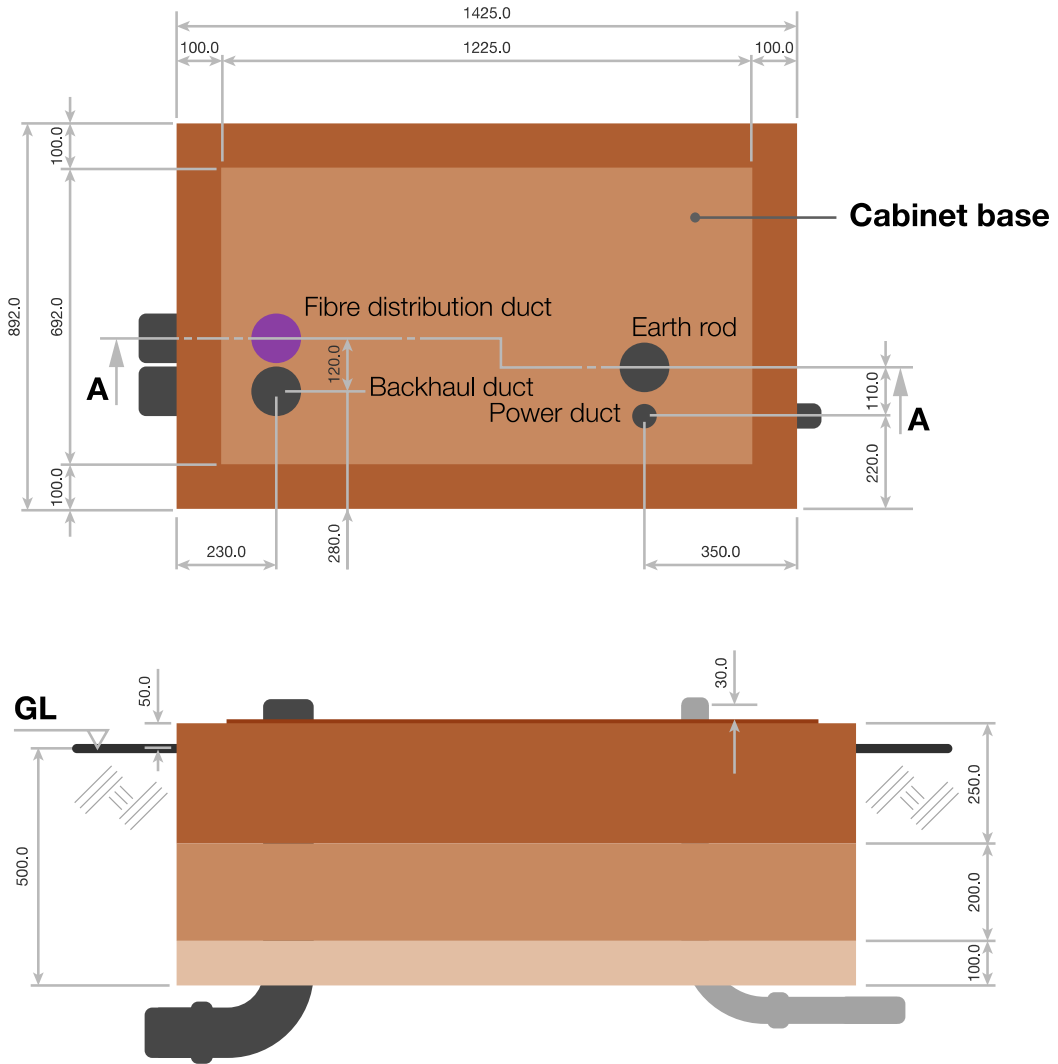

Figure 21 – D.1 voice and data (non-FIRS) cabinet plinth

GTC Technical Guidelines

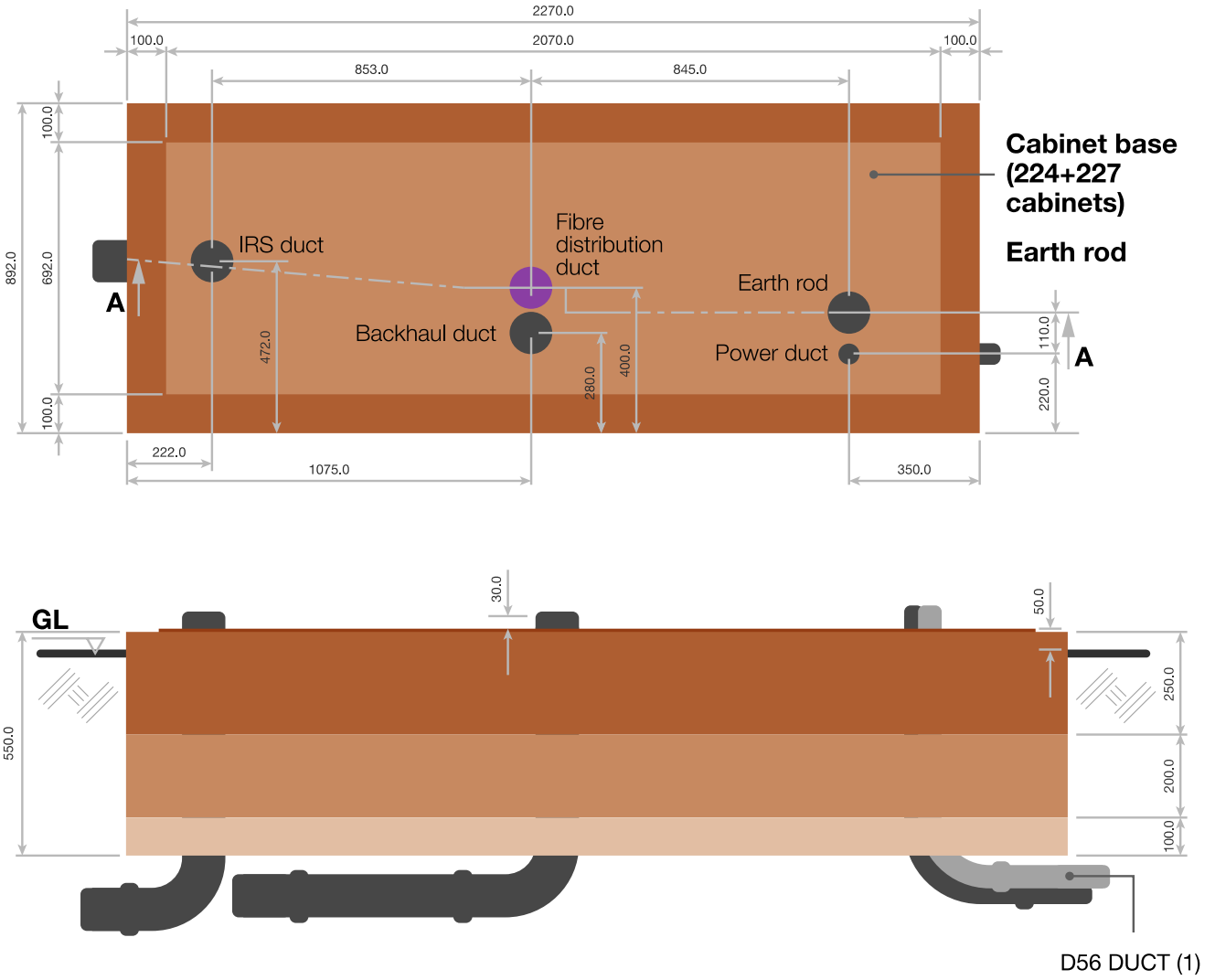

Figure 22 – D.2 voice and data with FIRS expansion bays cabinet plinth

GTC Technical Guidelines

Appendix D – Examples of OSCP Building and Cabinets



Figure 24 – E.1 voice and data (non-FIRS) cabinet



Figure 23 – E.2 voice and data with FIRS cabinet



Figure 25 – E.3 OSCP building



Figure 26 – E.4 satellite dish, DVB-T and DAB antenna installation on OSCP/substation building

GTC Technical Guidelines

Appendix D – Service Pipe and Duct Laying Register

Developers register of their groundworkers who have been trained and are competent to lay gas service pipe and ducting.

Groundworkers name	Groundworkers signature	Site Manager/ Agent name	Site Manager/ Agent signature	Date



Head Office

Synergy House
Woolpit Business Park
Woolpit
Bury St Edmunds
Suffolk
IP30 9UP

T: 01359 240363

E: info@gtc-uk.co.uk

W: www.gtc-uk.co.uk